

# TANDEM<sup>®</sup> MODULAR BLOCK

*INSTALLATION GUIDE*



# Table of Contents

---

HOW TO USE THIS GUIDE . . . . . 3

BEFORE YOU BEGIN . . . . . 3

**INSTALLATION INSTRUCTIONS FOR  
SEGMENTAL RETAINING WALL**

Retaining Wall Basics . . . . . 4

Laying Pattern . . . . . 5

Retaining Wall Installation Instructions - Best Practices . . . . . 6-9

Capping a Wall . . . . . 10

Steps. . . . . 11

Outside Curves . . . . . 12

Inside Curves . . . . . 12

Inside 90-Degree Corners . . . . . 13

Outside 90-Degree Corners . . . . . 14

Multi Stack Walls & Terraced Walls . . . . . 15

**INSTALLATION INSTRUCTIONS FOR  
FREESTANDING WALL**

Installation Instructions Best Practices . . . . . 16

Course Construction & Ending a Wall Without a Column . . . . . 17

Columns . . . . . 18

90-Degree Corners and Column . . . . . 19

# How to Use This Guide

---

## HOW TO USE THIS GUIDE

This guide is designed to provide you with ideas as well as information on product use and installation procedures. While this guide provides general guidelines, installation contractors should refer to construction drawings for final specifications.

## BEFORE YOU BEGIN

Advanced planning and careful layout at the job site help ensure a successful wall project.

- **Consult a professional engineer to design walls over 3 feet high, and have compaction tested by a qualified geotechnical engineer.**
- Review the site plan to confirm lot lines, wall location, length and elevations.
- Confirm the location of underground utilities.
- Seek all necessary building permits.
- Prepare a drawing of the site with the wall location, lengths and elevations.
- Check the block delivered to ensure it is the correct color.
- Be sure to use the right tools. Hand tools include a shovel, 4-foot level, dead-blow hammer, 2- or 3-pound hammer, chisel, hand tamper, hydraulic splitter and string line. Power tools include a circular saw with a masonry blade and a compactor.
- Be sure to use an exterior grade concrete adhesive to glue units in place where noted.
- Always wear protective eyewear.



**SAFETY NOTE:** Always use appropriate equipment, including safety glasses or goggles and respirators, when splitting, cutting or hammering units.

# Retaining Wall Basics

Segmental retaining walls typically fall into one of three categories.

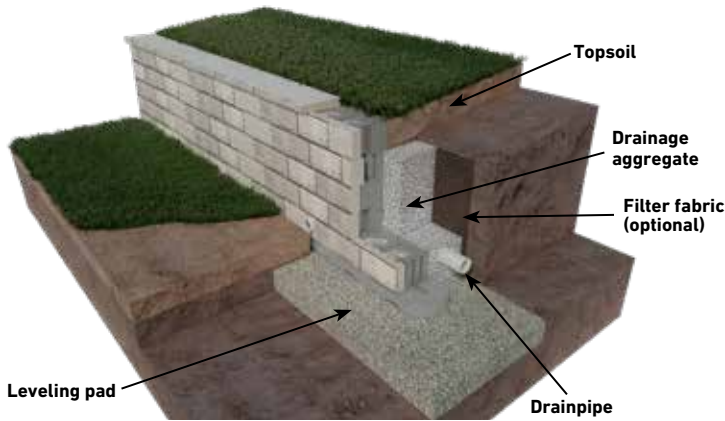

## GRAVITY RETAINING WALL

A gravity wall is a retaining wall that does not use soil reinforcement and has height limitations. An advantage of this type of retaining wall is that it requires a smaller work area behind the wall. A gravity wall relies on the weight, gravel fill and set back of the block to resist the soil forces being exerted on the wall.

The larger the stabilized soil mass, the more soil can be retained or held back. The geosynthetic reinforcement in the soil extends past the theoretical failure plane and serves to create a large rectangular mass of block and soil restraining the retained soil.



## MULTI-STACK RETAINING WALL

A multi-stack retaining wall offers a unique, nonconventional solution to project sites that do not have room for the excavation needed to install geosynthetic reinforcement. It is a retaining wall built with multiple Modular Blocks connected behind the wall veneer to create a deeper block system and eliminates the need for the construction of a mechanically stabilized earth zone behind the wall facing and requires substantially less excavation that is usually necessary in geosynthetic-reinforced wall construction.

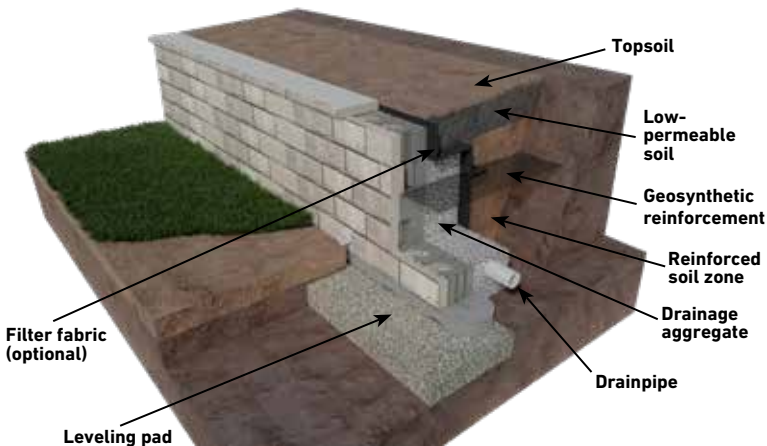

## GEOSYNTHETIC-REINFORCED RETAINING WALL

A geosynthetic-reinforced wall needs to be designed by a qualified engineer. There are (theoretically) no height limitations with reinforced retaining walls, and they are used in larger applications. They require more work area behind the wall. The block of soils is stabilized by introducing geosynthetic reinforcement layers into the soil mass behind the facing units.

# Laying Patterns

## WALL PATTERN

*Tandem faces should be laid in a one to one to one ratio ensuring that the large and small faces should be next to each other.*

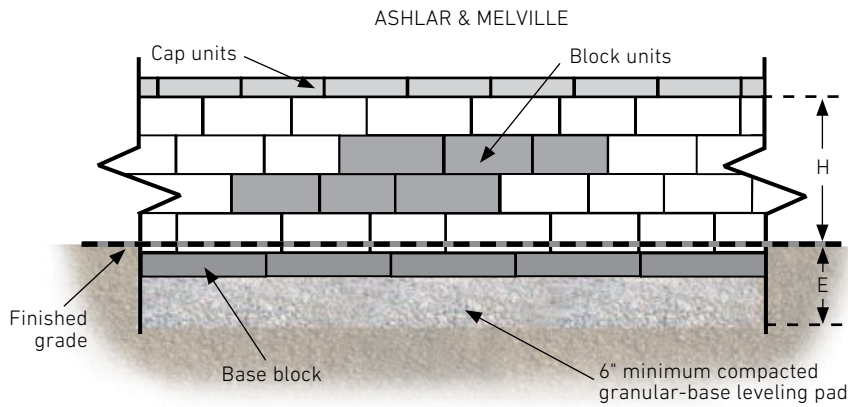

MELVILLE FACE



OR

ASHLAR FACE



False joints

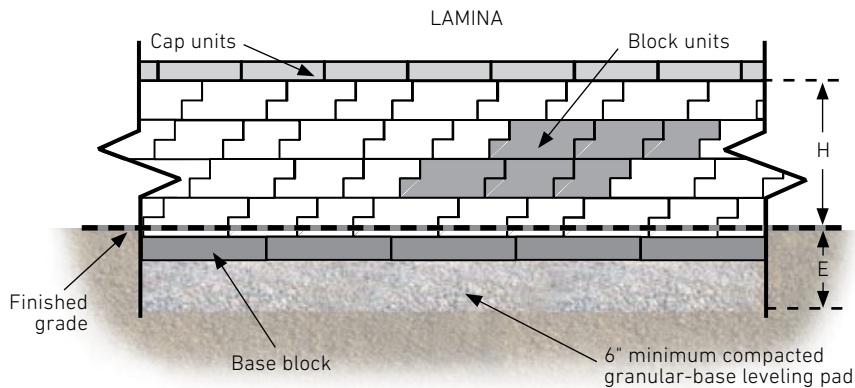

LAMINA FACE



False joints

## WALL UNITS & FACE STYLES

**Tandem Modular Block**



**Tandem Universal Connector**



**Ashlar - Face Style**



**Lamina - Face Style**



**Melville - Face Style**



# Retaining Wall Installation Instructions – Best Practices

## STAKE OUT THE WALL

- A surveyor shall locate the proposed base of wall location. Verify the wall location with the project supervisor.

## LEVELING PAD

- Excavate for the leveling pad to the lines and grades shown on the approved plans and excavate enough soil behind the wall for geosynthetic reinforcement material, if needed.
- The trench should be approximately 24 inches wide. *See Diagram 1.*
- Create a leveling pad of compacted base materials that extends a minimum of 6 inches in front of and 6 inches behind the base units. This leveling pad should be at least 6 inches deep after compaction. *See Diagram 2.*

## BASE COURSE

- Install the U Start Base Block with the hand holds down. Place the blocks so the outside curve of one block fits into the curve of the block next to it. Blocks should touch.
- Level blocks front to back and side to side with a dead-blow hammer. *See Diagram 3.*
- The base course and 2 inches of the wall will be buried.

## SYSTEM ASSEMBLY

- Assemble a retaining wall unit by applying the veneer unit to the modular blocks.
- Each modular block has a vertical tenon and each veneer has multiple mortises. The veneer units are joined to the modular blocks by simply sliding the tenon into the mortise to form a retaining wall block.
- Assembly of the retaining wall units always requires the use of two modular blocks for every veneer unit. *See Diagram 4.*

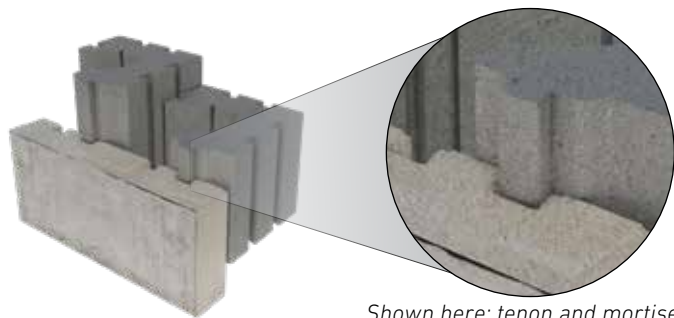

Shown here: tenon and mortise



Diagram 1—Excavation



Diagram 2—Leveling Pad



Diagram 3—Lay and level base block



Diagram 4— Assembled units on top of U Start block

# Retaining Wall Installation Instructions – Best Practices

## CONSTRUCTION OF 1ST WALL COURSE

- Clean any debris off the top of the U Start base course unit.
- Place the assembled retaining wall unit on top of the U Start Base Block making sure that the first course of wall is centered on the base block.
- For best results, refer to the laying patterns on page 5.
- Check to make sure units are level front to back and side to side on each course.
- Fill cores and voids with  $\frac{3}{4}$ -inch free draining aggregate prior to laying the next course of block. *See Diagram 5.*
- After filling the cores of the units add additional free draining aggregate behind the units extending at least 12 inches behind the blocks. Compact aggregate after each course of block is laid.



Diagram 5—Fill cores with free draining aggregate

## CONSTRUCTION OF SUBSEQUENT COURSES AND UNIVERSAL CLIP PLACEMENT

- Clean any debris off the top of the 1st course of wall units.
- Assemble and place the next course of wall units, maintaining a running bond.
- Insert a universal connector in each modular unit with the knuckle towards the soil. Push the connector down until it extends below the bottom of the block to create a  $\frac{3}{8}$ " setback. You need one connector per modular unit.
- Push the retaining unit forward until it locks in place. *See Diagram 6.*
- Level unit front to back and side to side with a dead-blow hammer.
- Fill cores and voids with  $\frac{3}{4}$ -inch free draining aggregate prior to laying the next course of block.
- Backfill with  $\frac{3}{4}$ -inch free draining aggregate directly behind the block, adding 6 inches at a time followed by proper compaction. Only lightweight hand operated compaction equipment is allowed within 3 feet from the back of the wall.
- Continue each course until the project is complete.



Diagram 6—Lock connector to the block in front



Tandem Universal Connector

Step 1



Step 2



Step 3



# Retaining Wall Installation Instructions – Best Practices

## STEPPING UP THE BASE

- Walls built on a sloping grade require a stepped base.
- Begin excavation at the lowest point and dig a level trench into the slope until it is deep enough to accommodate the base material and one entire block.
- At this point, step up the height of one block and begin a new section of base trench. Continue to step-up as needed to top of slope. Always bury at least one full unit at each step. *See Diagram 7.*



Diagram 7—Stepping up the base

## DRAINAGE (PER PLAN)

- Each project is unique. The grades on the site will determine at what level to install the drainpipe. Place the drainpipe (4-inch perforated piping) so water drains down and away from the wall into a storm drain, or daylight just above grade. *See Diagram 8.*
- Fill in the area behind the blocks with clean drainage aggregate, at least 1 foot from the wall. You may need to place and backfill several courses to achieve the proper drainage level.
- The outlet pipes should be spaced not more than every 50 feet and at low points of the wall. In order for the drainage aggregate to function properly, it must keep clear of regular soil fill.



Diagram 8—Daylight

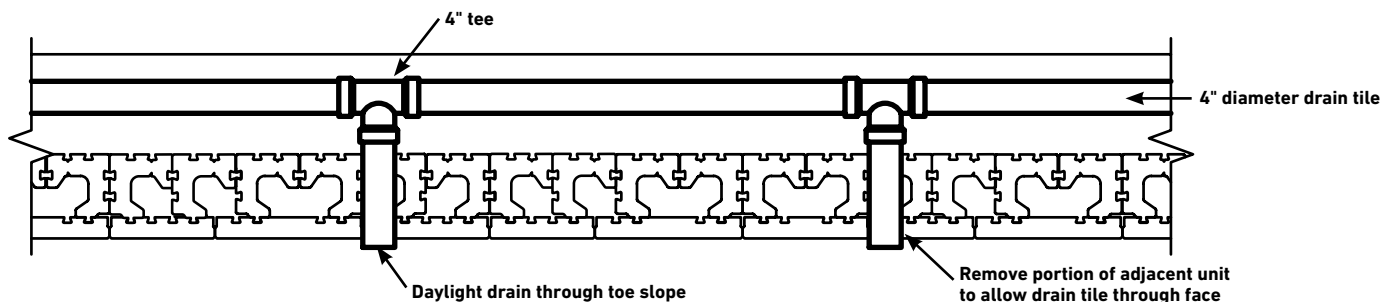

## REINFORCED BACKFILL PLACEMENT AND COMPACTION (PER PLAN)

- Place reinforced backfill in 6 to 8 inch loose lifts and compact to the densities specified on the approved wall constructions plans. *See Diagram 9.*
- Only hand operated compaction equipment is allowed within 3 feet of the back of the wall.
- If the compaction equipment is too small to achieve the required compaction, thinner lifts should be used.
- Install each subsequent course in a similar manner. Repeat procedure to the extent of the wall height.



Diagram 9—Compaction



# Retaining Wall Installation Instructions – Best Practices

## GEOSYNTHETIC REINFORCEMENT PLACEMENT (PER PLAN) BATTERED WALL INSTALLATION ONLY

- Refer to the approved wall construction plans for the reinforcement type, strength, and placement location. Measure and cut the reinforcement to the lengths shown on the plans.
- Ensure the reinforced backfill is placed and compacted flush with the top of the units and is graded reasonably flat prior to reinforcement placement. Clean any debris off the top layer of blocks prior to reinforcement placement.
- The reinforcement has a primary strength direction, which must be laid perpendicular to the wall face.
- Place the reinforcement within 1 inch of the front of the units. *See Diagram 9.*
- Apply the next course of blocks to secure the reinforcement in place. Insert Universal Connector into one of the mortise on the back of the modular block to create the proper setback. Pull the reinforcement hand taut and place staples, stakes, or fill at the back of the reinforcement to keep tension during placement of drainage aggregate and reinforced backfill.
- Place a minimum of 6 inches of reinforced backfill prior to operating equipment above the reinforcement. Avoid sudden braking or turning on fill placed over the reinforcement.

## FINISH GRADE AND SURFACE DRAINAGE

- Protect the wall with a finished grade at the top and bottom. To ensure proper water drainage away from the wall, use 6 inches of soil with low permeability and seed or plant to stabilize the surface. *See Diagram 10.*
- Consult the wall design engineer if water may be directed behind the wall. If needed, create a swale to divert water away from the wall. This will minimize water seeping into the soil and drainage aggregate behind the wall.

## SITE CLEANING AND RESTORATION

- Brush off the wall and pick up any debris left from the construction process. Notify the job superintendent in writing of the completion and that it is ready for final inspection and acceptance.
- Planting vegetation in front and on top of the wall will help reduce the chance of erosion.
- Following these best practices for construction will ensure the success of your retaining wall system. These instructions are meant as general guidelines. Site-specific conditions may warrant additional installation requirements.
- Oldcastle® recommends you consult a professional engineer to design walls over 4 feet high, and have compaction tested by a qualified geotechnical engineer.



Diagram 9—Action



Diagram 10—Low permeable soil

# Capping a Wall

## CAPPING WALL

- Always start capping from the lowest elevation. Once caps are aligned, caps should be glued in place using a concrete adhesive.

## CURVES

Lay out the cap units side by side with the same face facing out. If there's a need to adjust for project's radius, make cuts at least every other cap as needed for the most pleasing aesthetic.

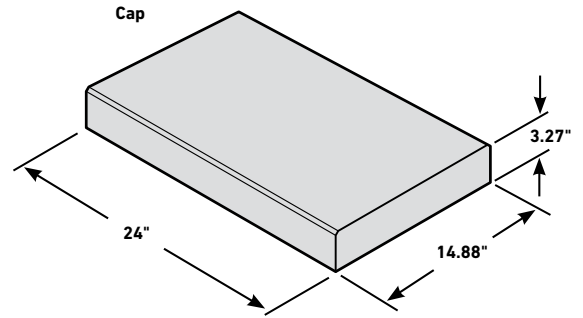
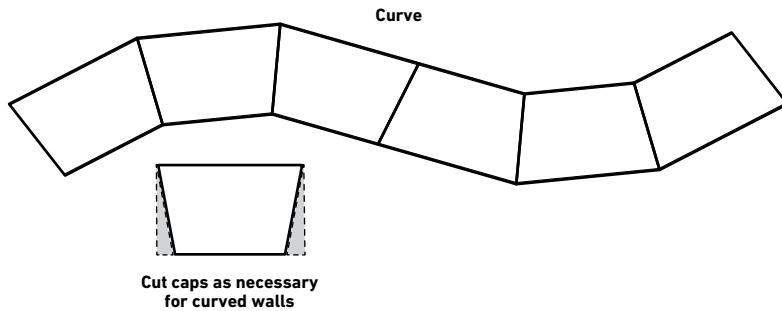

## 90-DEGREE CORNERS

Saw-cut two caps to achieve a 45-degree mitered corner. See *Diagram 11*.

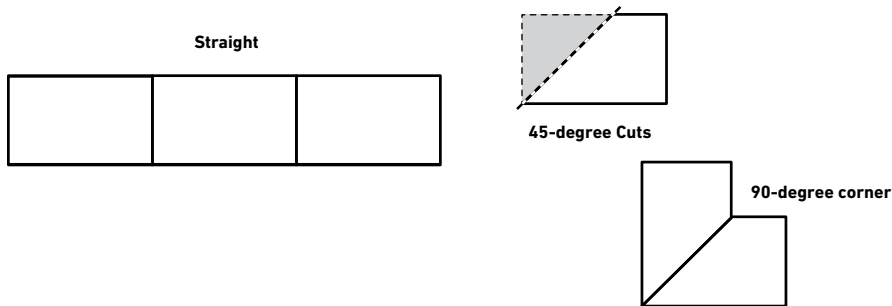
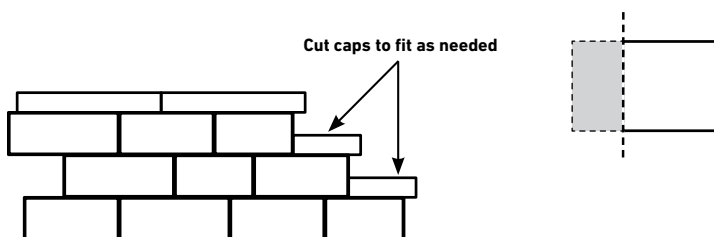

Diagram 11—45-degree miter

## STEPPING THE CAP

Saw-cut caps to size depending on ending sized block. Allow at least a 2 inch overhang of the cap on each end. Keep cut end facing inward toward wall.



# Steps

## STEPS

- Steps can be constructed by creating layers of step landings
- The base landing is created by connecting multiple modular block together
- The size of the landing varies based on the number of risers to be constructed
- Once the Modular Blocks are laid, the veneer to be used as the riser are joined to the modular block by sliding the tenon into the mortise. If you want to have veneer on the side, use the Universal Clips to attached the veneer to the modular block.
- A second course of steps are constructed above the first course and glued with a concrete adhesive.
- Construction continues until desired number of risers is reached
- Cap the risers with a cap of choice
- Clean stone must be installed behind the structural units. It is also recommended to install clean stone in the empty spaces of the modular block.

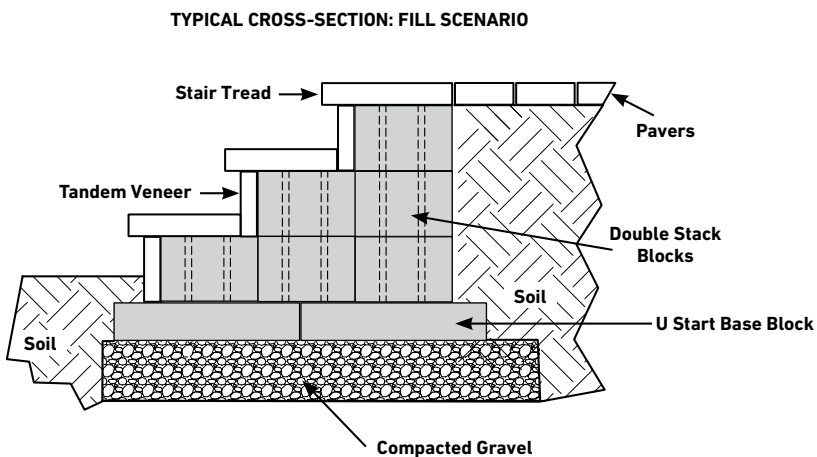

# Outside Curves & Inside Curves

## CURVES

- Building a 6 foot radius curved wall is possible by using full and partial modular block.
- To achieve a tighter radius only use the small and medium veneers.
- To create a partial Modular Block, split the block at the break line using a dead blow hammer. *See illustration to the right.*
- The minimum radius of an outside curved wall is 6 feet; 8 feet (Lamina).
- **Note:** the Lamina veneer is not recommended for curved retaining walls.

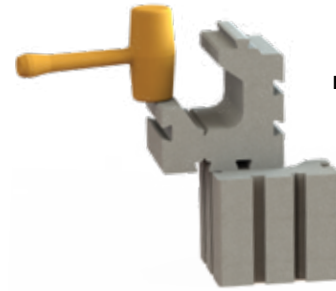

Use a mallet or dead blow hammer to break off tail at the split.

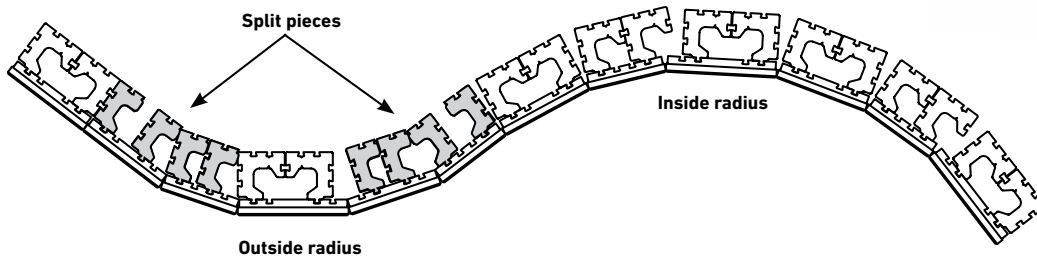
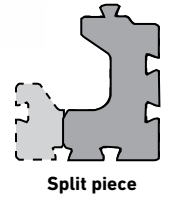

Geosynthetic Reinforcement Placement - 1st course

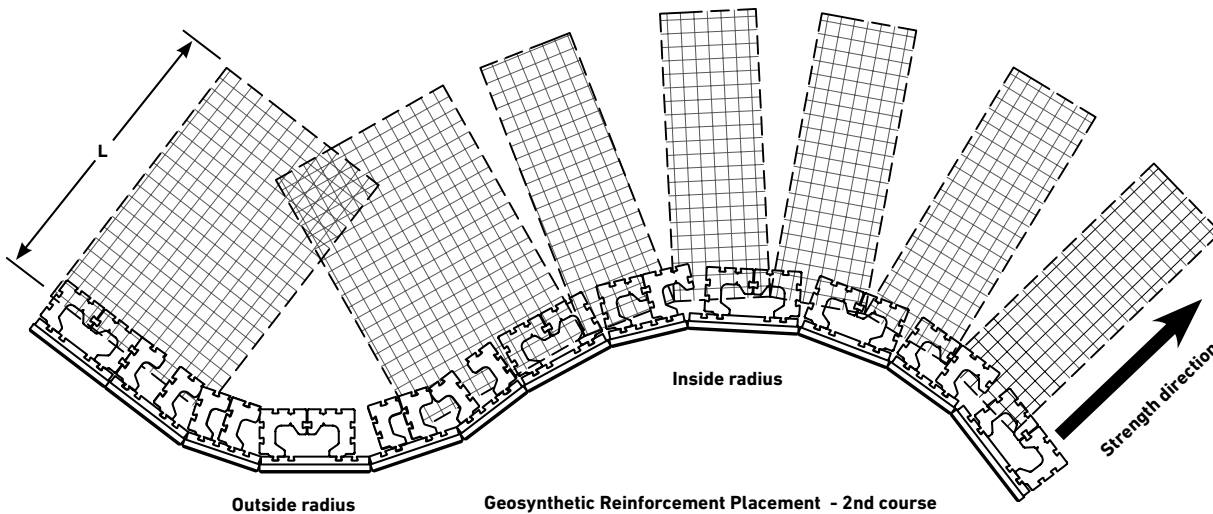

Geosynthetic Reinforcement Placement - 2nd course

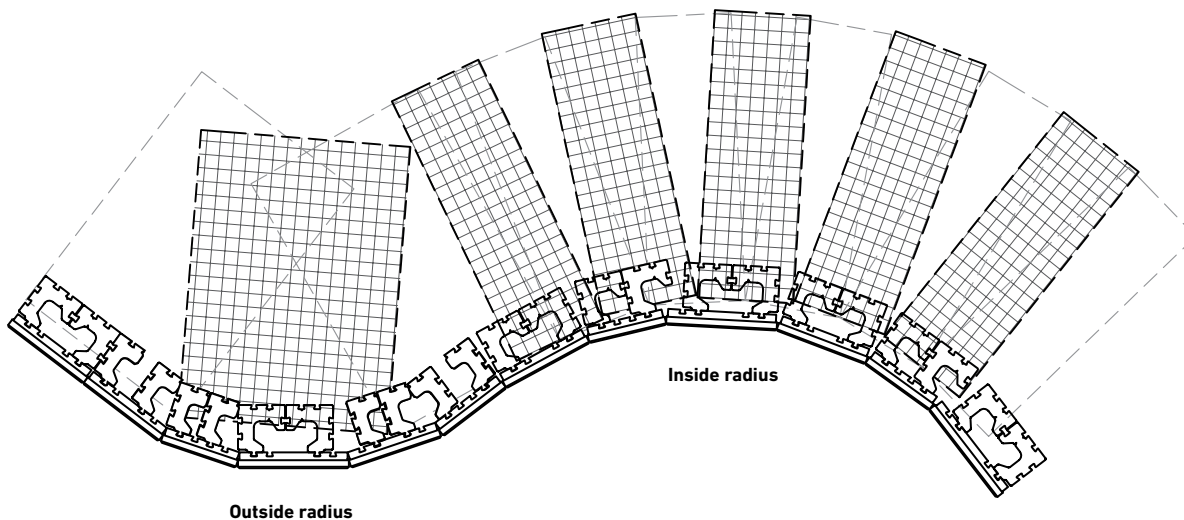

# Inside 90-Degree Corners

## CORNERS

- The veneer units are reversible to form inside or outside corners
- Corner veneers have finished end. *See pallet layout below.*
- The corner unit is formed by applying the veneer to the Modular Block using the Universal Connector. *See Diagram 12.*
- The position of the corner unit is alternated 90° from course to course
- Once corner units are in position, glue with a concrete adhesive
- Additional Modular Blocks can be installed to reinforce the corner



Diagram 12—Corner unit formed

Top view of pallet layout.  
Corner units identified in orange triangle

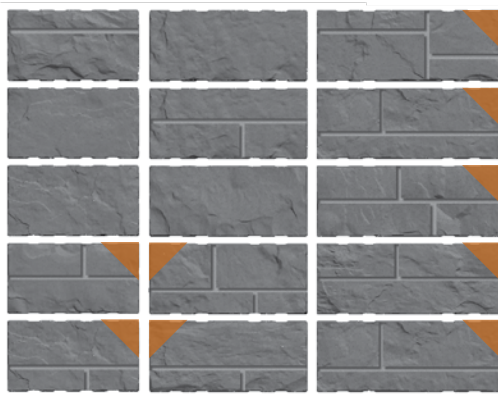

Finished End  
(Corner Unit)



Unfinished End

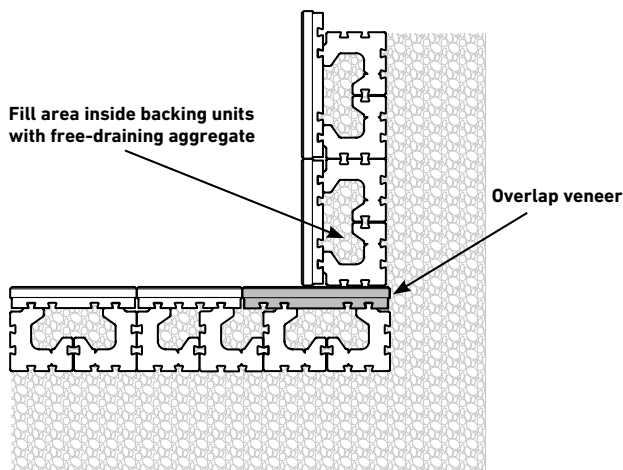

Inside 90-Degree Corner

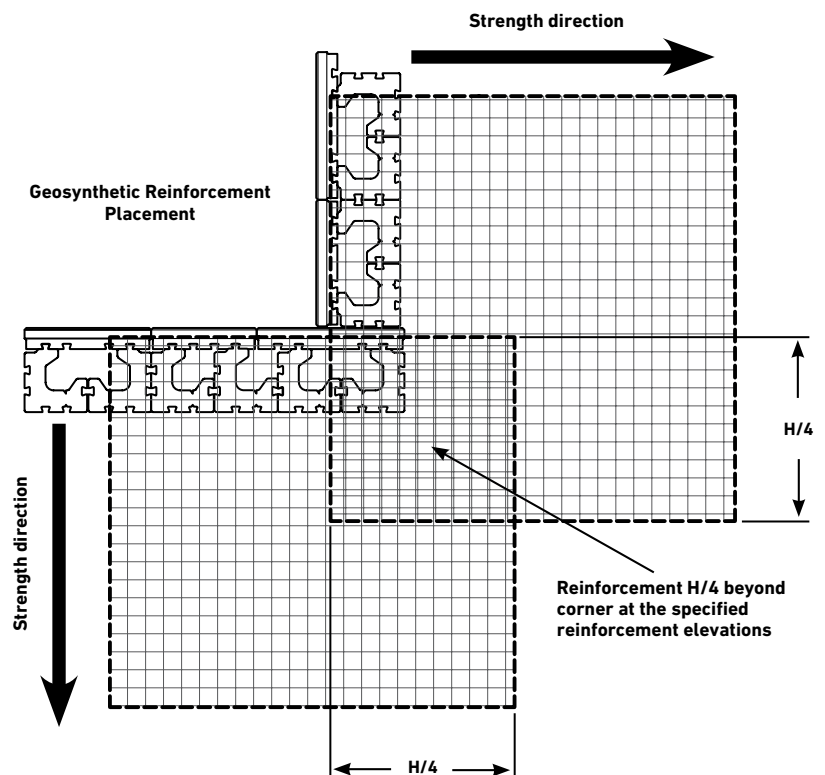

# Outside 90-Degree Corners

## CORNERS

- The veneer units are reversible to form inside or outside corners
- Corner veneers have a finished end and a unfinished end.  
*See pallet layout below.*
- The corner unit is formed by applying the veneer to the Modular Block using the Universal Connector.
- The position of the corner unit is alternated 90° from course to course
- Once corner units are in position, glue with a concrete adhesive.
- Additional Modular Blocks can be installed to reinforce the corner.  
*See Diagram 13.*

Top view of pallet layout.  
Corner units identified in orange triangle

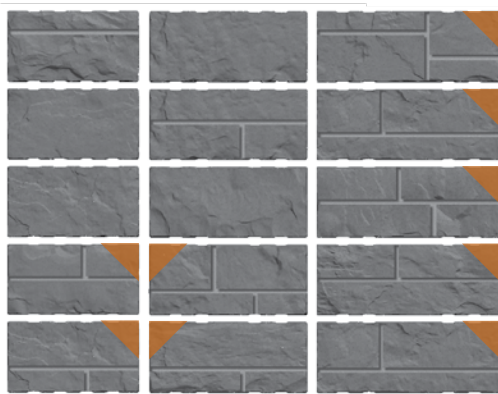

Place **connectors** in channels to secure veneer

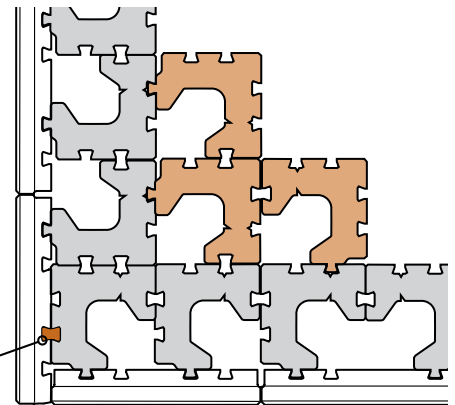

Diagram 13—Additional units for reinforced corner



Finished End  
(Corner Unit)



Unfinished End

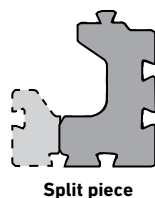
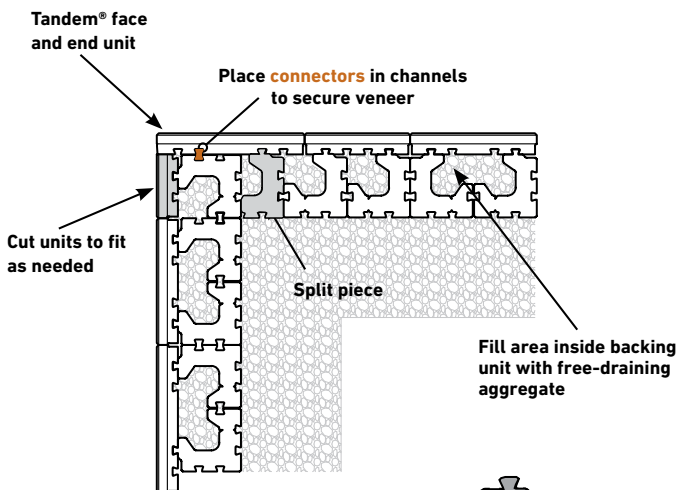

Split piece

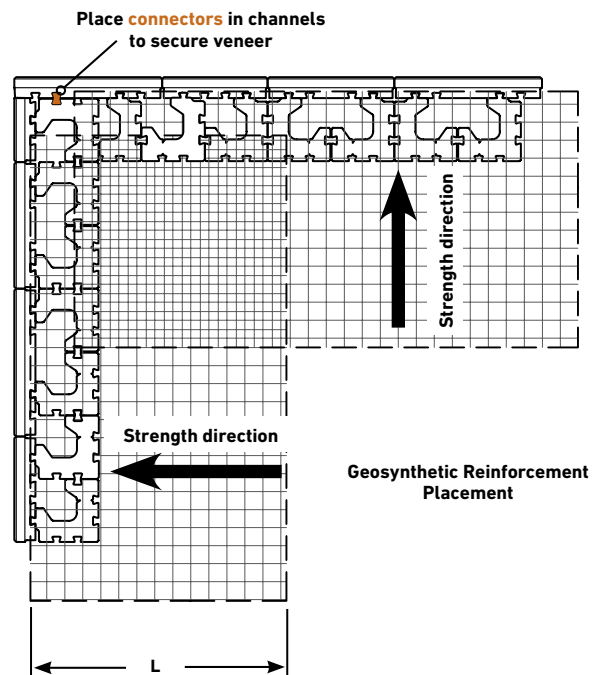

**NOTE:** In the "cross-over area" of the reinforcement, one of the layers of reinforcement should be lowered or raised one course to allow placement of the reinforcement strength direction properly oriented. The reinforcement should not extend into the segmental retaining wall units on the return leg of the 90-degree corner.

# Multi Stack Walls and Terraced Walls

## MULTI STACK WALL

The maximum gravity wall height for a retaining wall constructed with the Tandem Modular Block is 3 feet. The flexibility of the Tandem Modular Block allows you to connect the blocks to increase the depth of the retaining wall unit which allows a wall to be constructed higher than 3 feet without the need for geosynthetic reinforcement. Connect the blocks by sliding the vertical tenon into the mortise at the back of the modular block. *See Diagram 14, 15 & 16.*

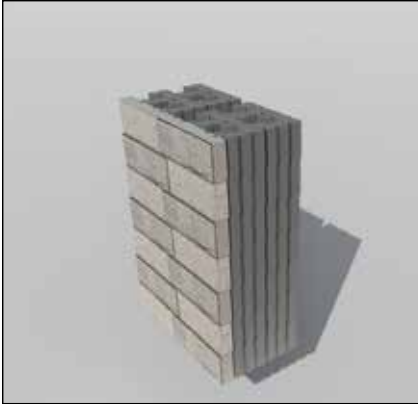

Diagram 14—2 deep. Maximum height of 4 feet

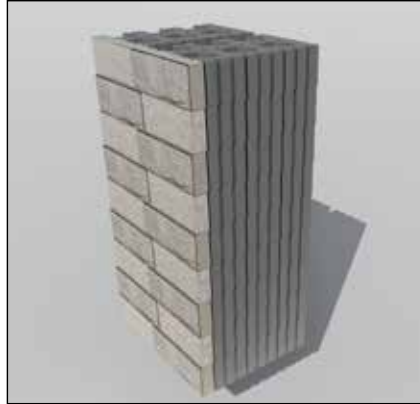

Diagram 15—3 deep. Maximum height of 5 1/2 feet

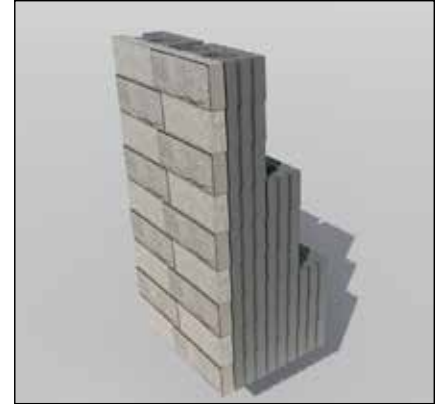
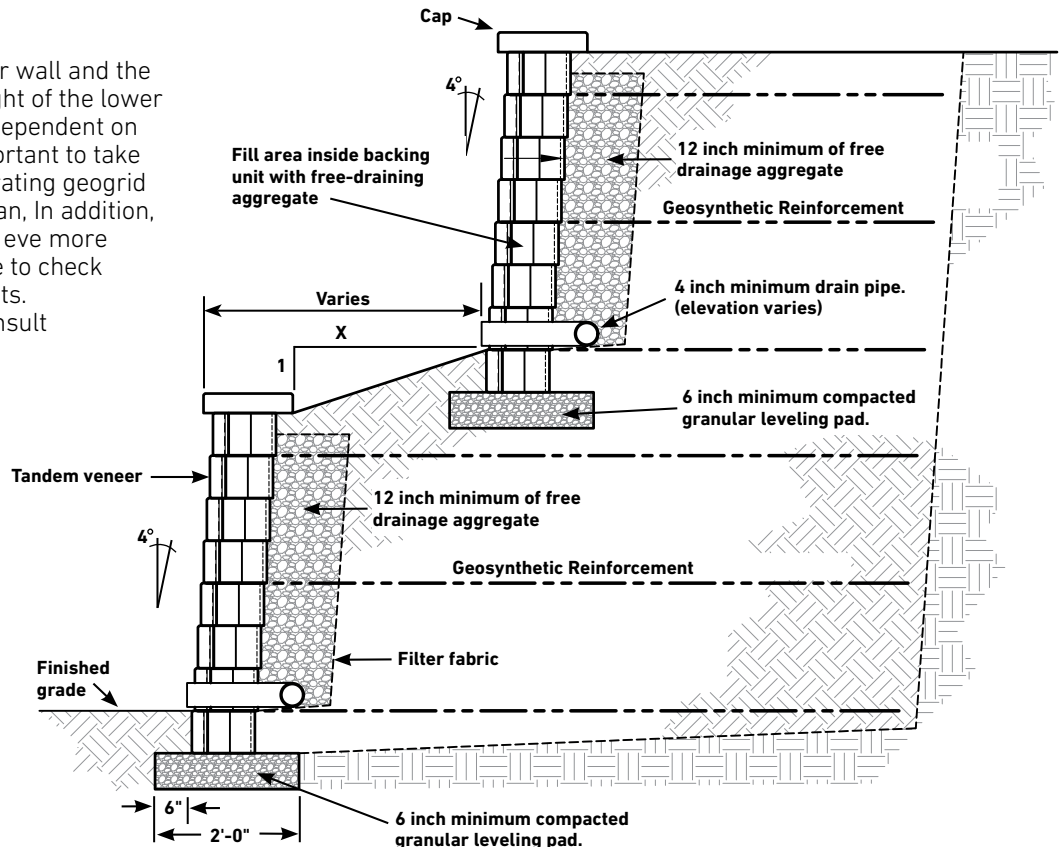

Diagram 16—3 deep, 2 deep & 1 deep. Maximum height of 4 1/2 feet

## DEPENDENT TERRACED WALLS

When the distance between the lower wall and the upper wall is less than twice the height of the lower wall, the walls become structurally dependent on each other. In this situation, it is important to take global stability into account, incorporating geogrid – and longer layers – into the wall plan. In addition, structurally dependent walls require even more excavation, backfill and time. Be sure to check the wall plan for specific requirements. For structurally dependent walls, consult with a qualified engineer.



# Freestanding Wall Installation Instructions – Best Practices

## STAKE OUT THE WALL

- A surveyor shall locate the proposed base of wall location. Verify the wall location with the project supervisor.

## LEVELING PAD

- Excavate for the leveling pad to the lines and grades shown on the approved plans and excavate enough soil behind the wall for geosynthetic reinforcement material, if needed.
- The trench should be approximately 24 inches wide. *See Diagram 17.*
- Create a leveling pad of compacted base materials that extends a minimum of 6 inches in front of and 6 inches behind the base units. This leveling pad should be at least 6 inches deep after compaction. *See Diagram 18.*



Diagram 17—Excavation

## BASE COURSE

- Install the U Start Base Block with the hand holds down. Place the blocks so the outside curve of one block fits into the curve of the block next to it. Blocks should touch.
- Level blocks front to back and side to side with a dead-blow hammer. *See Diagram 19.*
- The base course and 2 inches of the wall will be buried.



Diagram 18—Leveling Pad

## SYSTEM ASSEMBLY

- Assemble a freestanding wall unit by applying the veneer units to both sides of the modular blocks. *See Diagram 20.*
- Each modular block has a vertical tenon and each veneer has multiple mortises. The veneer units are joined to the modular blocks by simply sliding the tenon into the mortise to form a retaining wall block.
- Assembly of the freestanding wall units always requires the use of two modular blocks for every veneer unit.



Diagram 19—Lay and level base block

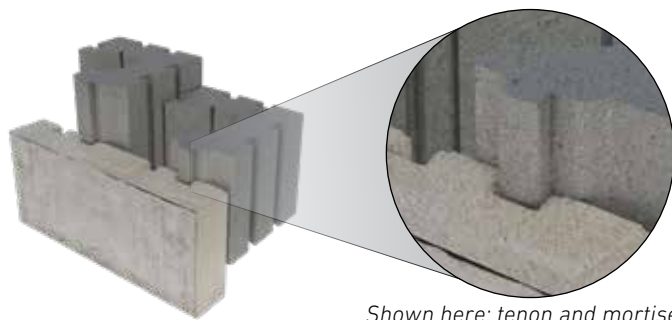

Shown here: tenon and mortise

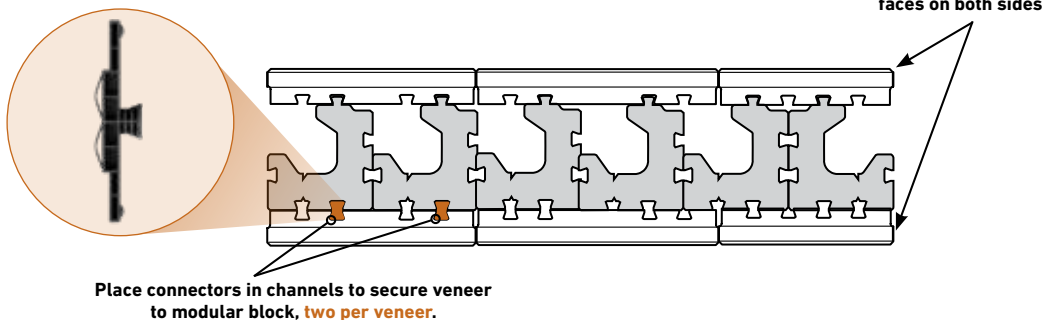

Diagram 20—Placing veneers onto modular block



# Course Construction & Ending a Wall with & Without a Column

## CONSTRUCTION OF WALL COURSES

To continue with additional courses, assemble units in the same manner as the previous step. Place the assembled units on the course below ensuring that the veneer units are staggered over the bond below. Glue each modular unit to the course below. *See Diagram 21.*

## ENDING A WALL WITHOUT A COLUMN

When finishing a wall end without a column build the wall to the desired length. Install the veneers on one side of the modular units flush to the end. Install the veneer on the other side extending past the modular unit by the thickness of one veneer. Make sure the exposed end of the veneer is the natural edge and not the manufactured edge. Line up and mark a unit to be cut to finish the end of the wall. *See illustration below.* Make sure to cut off the manufactured edge leaving the natural edge exposed. Install this cut unit inserting two universal connectors into the grooves in both the modular unit and the veneer. *See Diagram 22.*



Diagram 21—Second course construction



Diagram 22—Wall end example

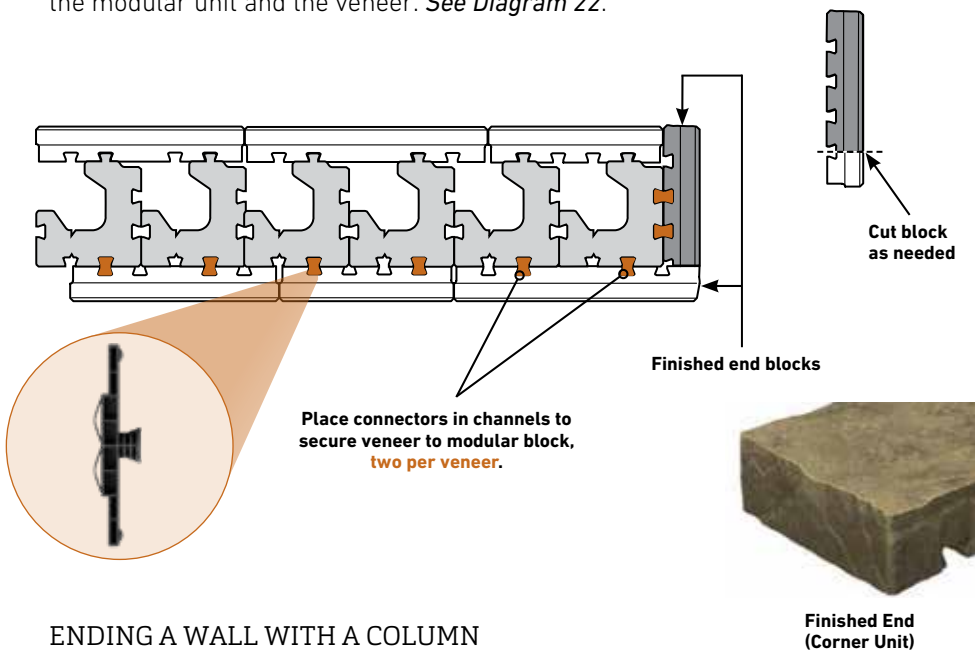

## ENDING A WALL WITH A COLUMN

To end a free-standing wall with a column, start by constructing the first course of the column. Using four Modular units, interlock them with the tongue and groove. *See Diagram 24 on the next page.* Add four large veneer units to this assembly utilizing two universal connectors for each veneer. Start building the wall flush to, and centered on the assembled column units. Add the veneer units to the wall and build to length. *See Diagram 25.* Add the second course of column in a similar fashion rotating the bond at the corners. Continue with the second course of wall. Continue in this fashion until you reach the desired height of column and wall.

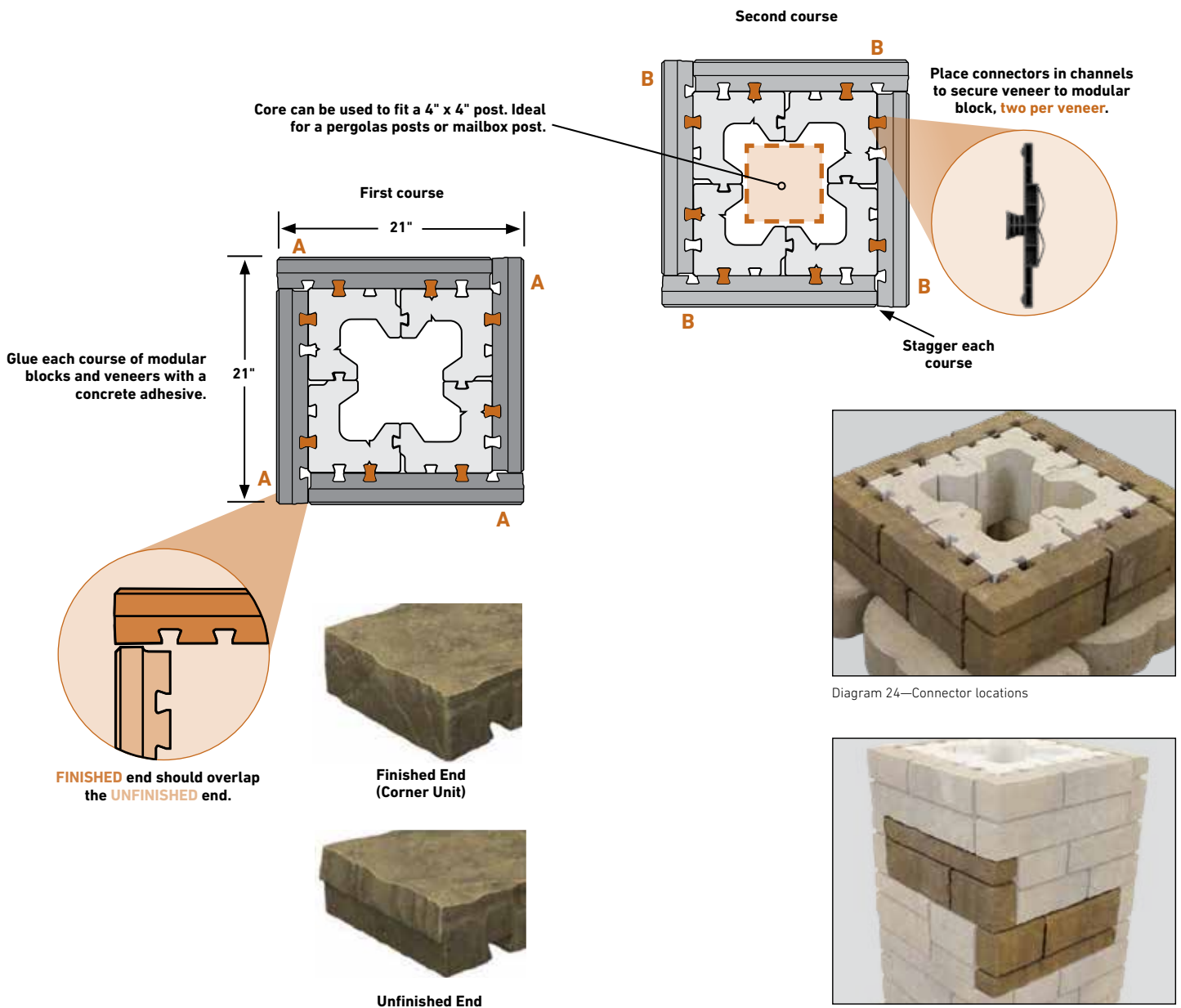

Diagram 23—Ending a wall at a column example

# Columns

## COLUMNS

To build a column you start by excavating 12 inches below grade and installing an aggregate leveling pad 6 inches thick after compaction and extends at least 6 inches on each side beyond the column dimension. Install 4 U-Start base blocks on the aggregate pad leveling front to back and side to side. Using four Modular units, create your first course of column by interlocking the tongue and groove system together forming an approximate 16-inch by 16-inch square formation. *See Diagram 24.* Attach a large veneer to each side of your column using 2 universal connectors on each veneer. Make sure the one end of the veneer that protrudes beyond the edge has the natural edge exposed and not the manufactured edge. Using 4 more Modular units build the second course in the same manner using Structurebond between the course to secure them in place. Attach 4 veneers to this course making sure to stagger the bonds at the corners and ensure that all exposed ends are the natural ends and not the manufactured ends. *See Diagram 25.* Continue to build your column to the desired height.



# 90-Degree Corner at Column

## 90-DEGREE CORNER AT COLUMNS

To build a 90 degree corner at a column start by constructing the first course of the column. Using four Modular units, interlock them with the tongue and groove. Add four large veneer units to this assembly utilizing two universal connectors for each veneer. Start building one of the walls flush to, and centered on the assembled column units. Add the veneer units to the wall and build to length. Build the second wall flush to and centered on the column perpendicular to the first wall. Add the veneers this wall and build to length. Add the second course of column in a similar fashion rotating the bond at the corners. Continue with the second course on each of the two walls. Continue in this fashion until you reach the desired height of column and walls.

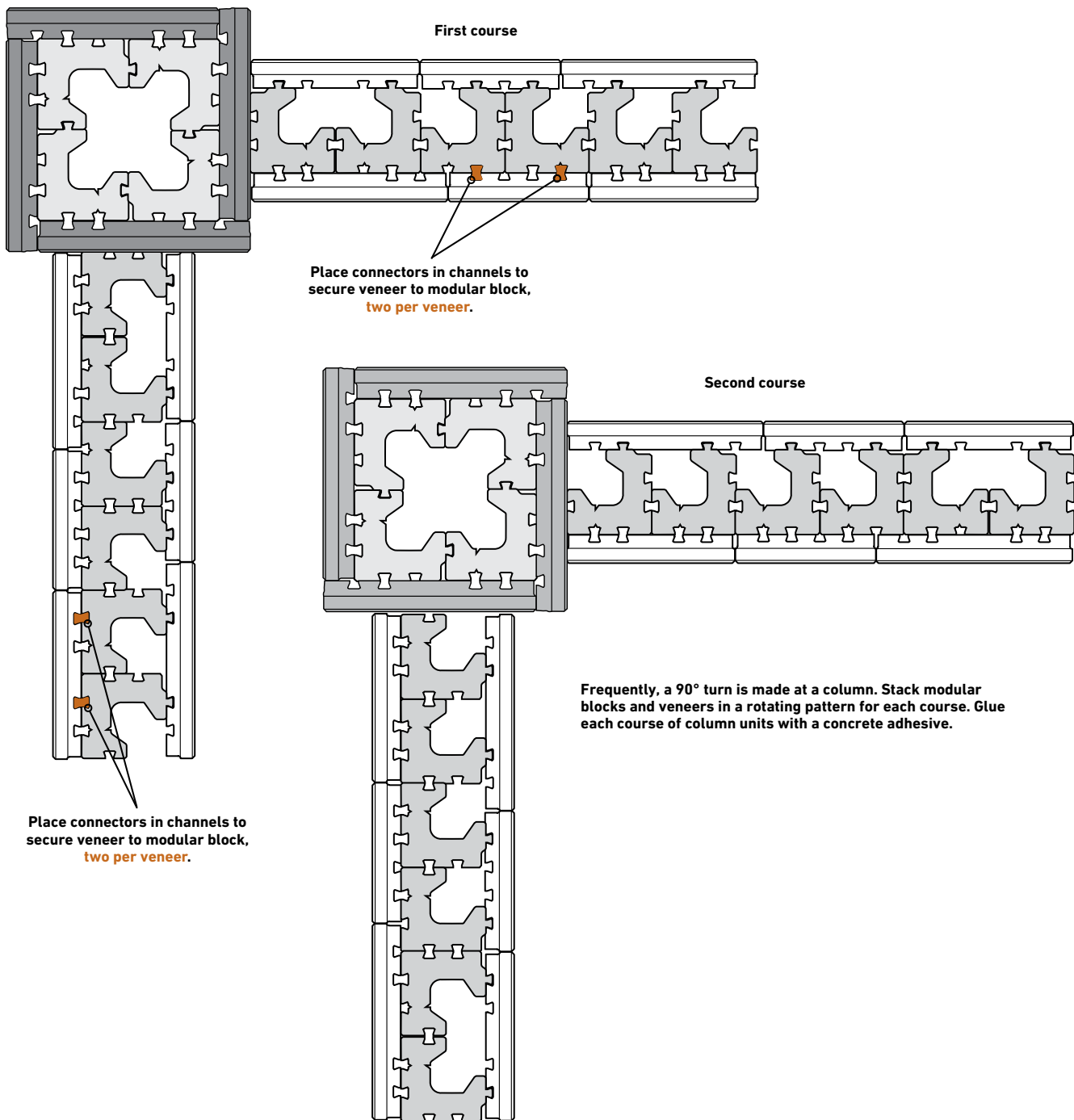



**Oldcastle APG - A CRH Company**  
400 Perimeter Center Terrace, Ste. 1000  
Atlanta, GA 30346  
☎ (678) 461-2838

For more info visit: [Belgard.com](http://Belgard.com)

## GET SOCIAL



[Pinterest.com/Belgard](https://www.pinterest.com/Belgard)



[Facebook.com/OutdoorLivingbyBelgard](https://www.facebook.com/OutdoorLivingbyBelgard)



[Belgard.com/Blog](http://Belgard.com/Blog)



[YouTube.com/BelgardHardscapes](https://www.youtube.com/BelgardHardscapes)



[Twitter.com/Belgard](https://twitter.com/Belgard)



[Instagram.com/BelgardOutdoorLiving](https://www.instagram.com/BelgardOutdoorLiving)